

Support Bracket WK 100/100, 100/100-40 and 150/150

Width of size 100/100-40 is 40 mm.

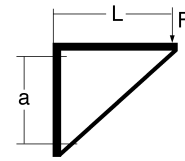
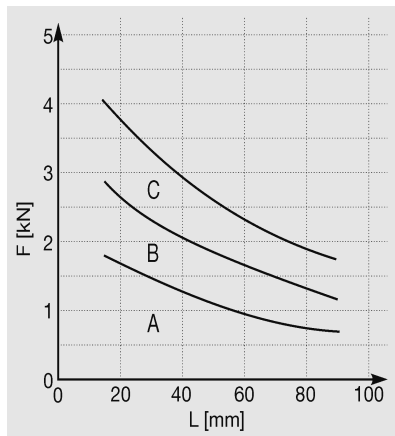
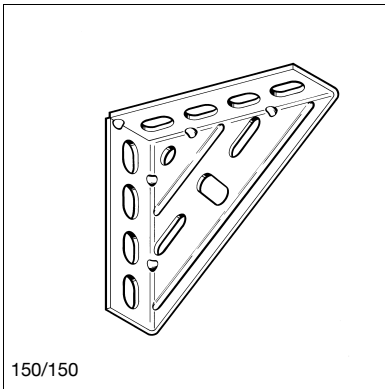
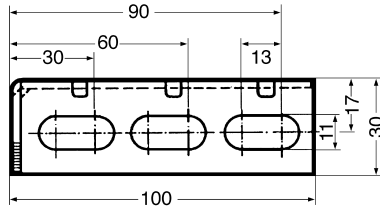

Anchor load classes (top/bottom):
 A = 1.5/1.5 kN
 B = 2.5/1.5 kN
 C = 3.5/1.5 kN
 a = 70 mm
 f ≤ 1 mm
 $\sigma_{perm} \leq 160 \text{ N/mm}^2$

Support Bracket 150/150

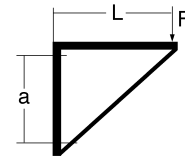
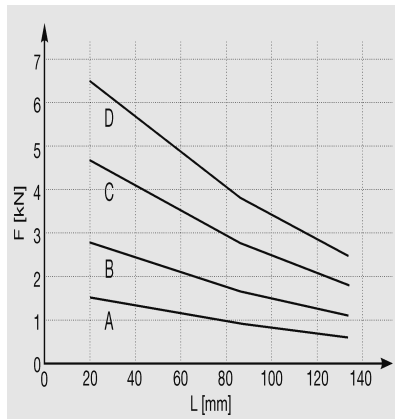
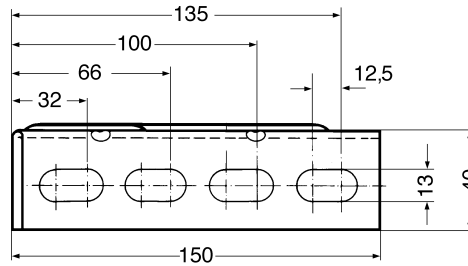

Anchor load classes (top/bottom):
 A = 1.5/1.5 kN
 B = 2.5/1.5 kN
 C = 3.5/1.5 kN
 D = 6.0/3.5
 a = 115 mm
 f ≤ 1.5 mm
 $\sigma_{perm} \leq 160 \text{ N/mm}^2$