

sikla



siMetric

**THE INNOVATIVE ASSEMBLY
SYSTEM BY SIKLA.**





FAST. FLEXIBLE. MODULAR.

Discover





Introducing siMetrix by Sikla: the ultimate solution for planning and assembling steel frames.

With the innovative 1-2-3 principle, siMetrix seamlessly integrates with existing infrastructures and Sikla products, providing unparalleled flexibility in your planning tools. Experience the future of construction with siMetrix.

siMetrix!

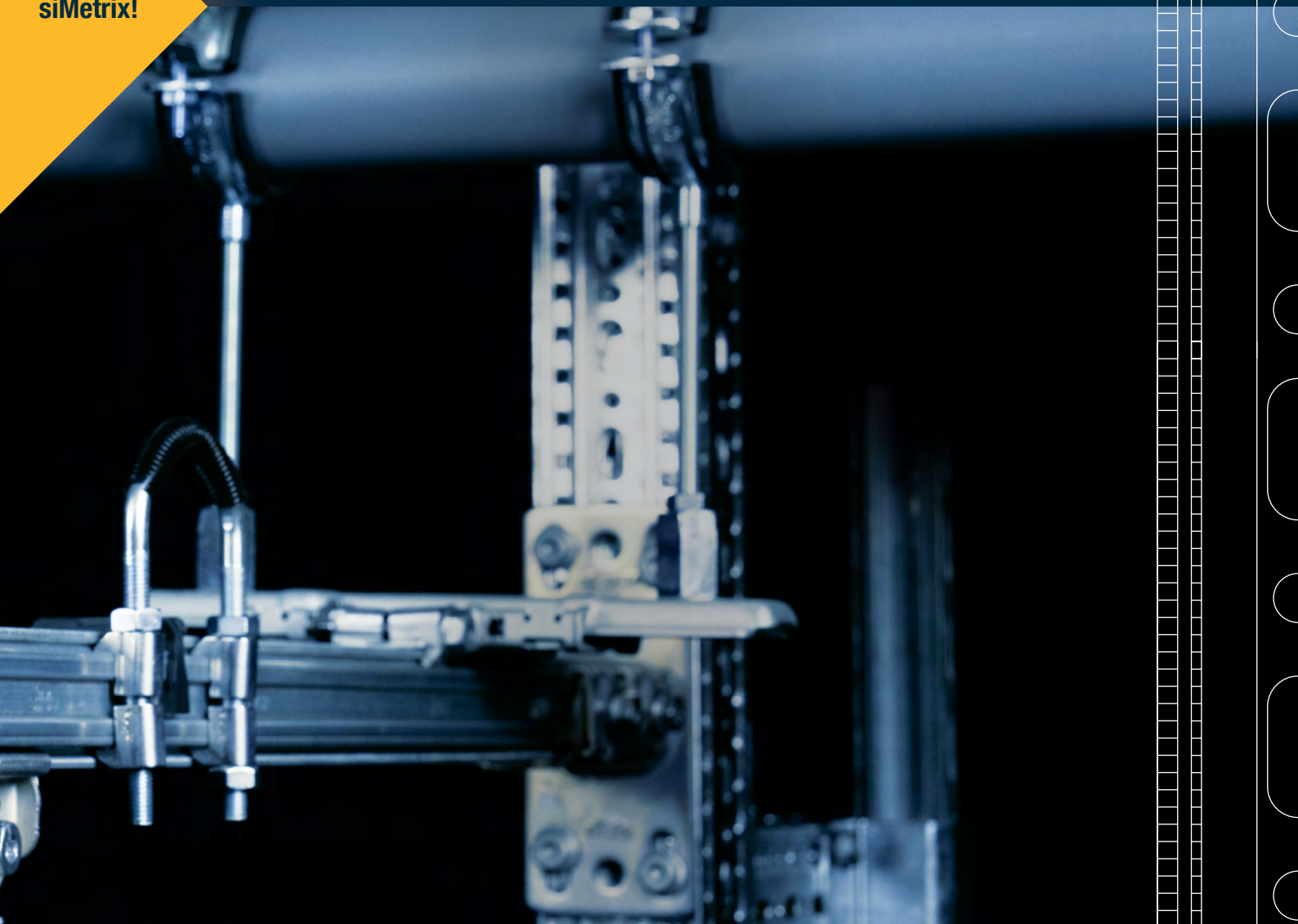



ENGINEERING EXCELLENCE

siMetrix - the missing link!

**Modular and flexible
due to identical geometries
on all faces**



**Quick installation thanks to
an innovative click system and
One-Screw Technology**



**Modular connections to
existing Sikla systems such
as Pressix 27/41 CC and the
siFramo 80/100**



**Compatible with existing
primary building structures
such as walls, ceilings and
traditional steel beam**



**The compact design
allows for space-saving
configurations**

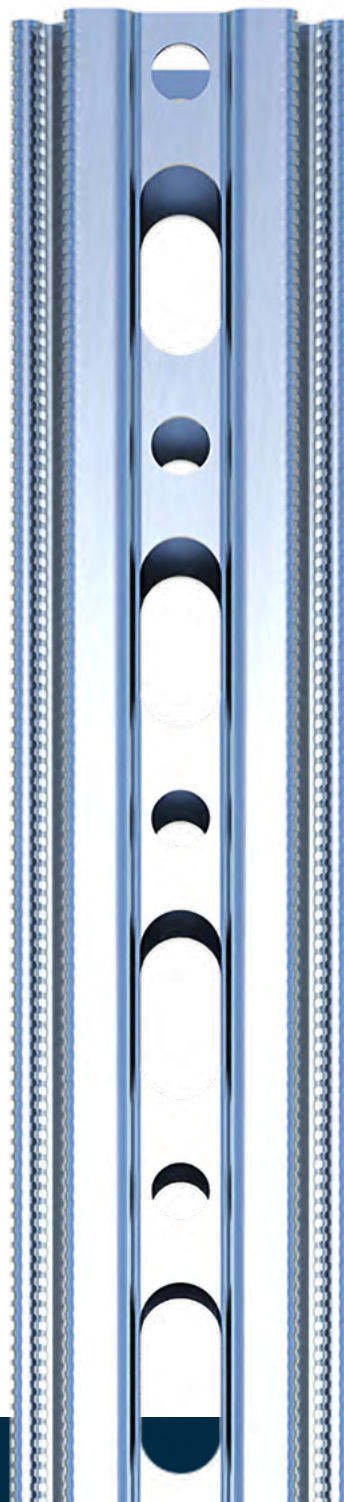

**More accessories
and solutions
available**



THE INNOVATIVE 1-2-3 PRINCIPLE

Planning has never been simpler!

This system offers flexibility for complex, three-dimensional structures by connecting all components with one screw only.

The newly developed and patented system with
One-Screw Technology.

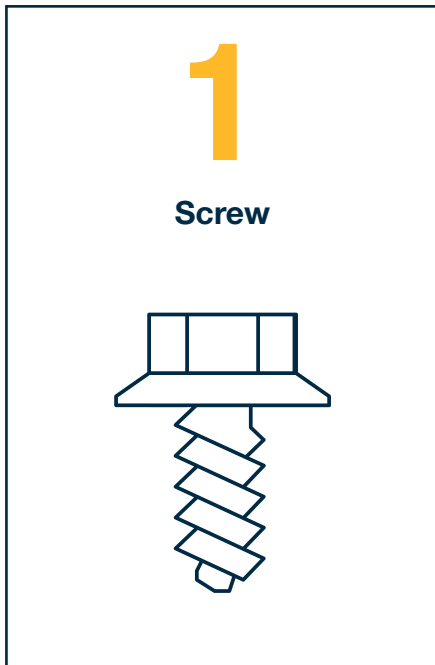

The same type
of screw for
any frame

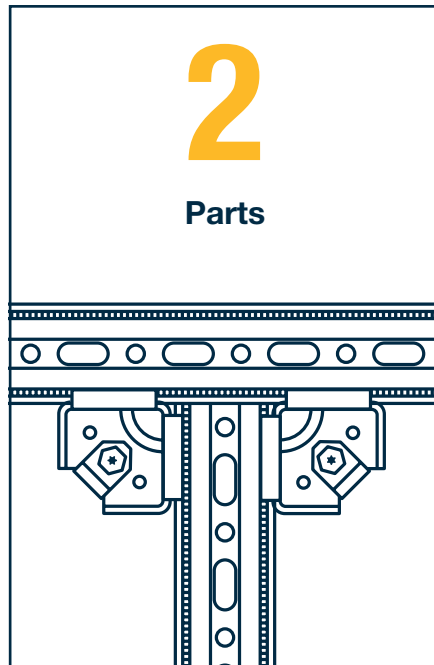

Two central parts
allow for endless
possibilities

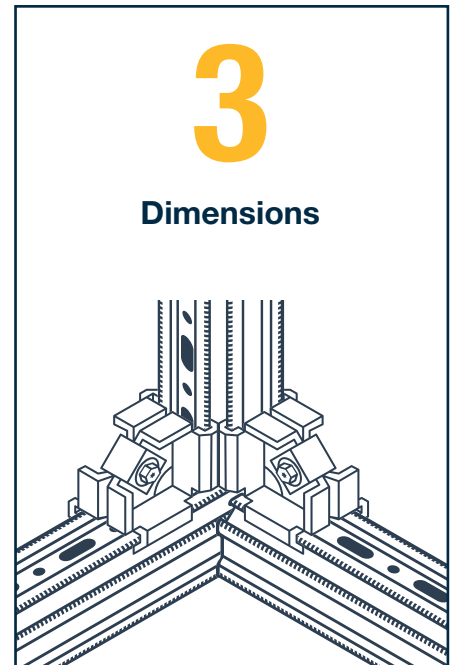

Complex, modular
constructions,
easy to assemble



INTEGRATED PROJECT PLANNING!

siMetrix from planning to completion!

Now available on all
SiCAD4 software tools to
optimise BIM projects

Simplified planning thanks to
fewer parts, modular components
for seamless connectivity

Reduce time and cost
with effective planning

Available on Sikla
CAD libraries

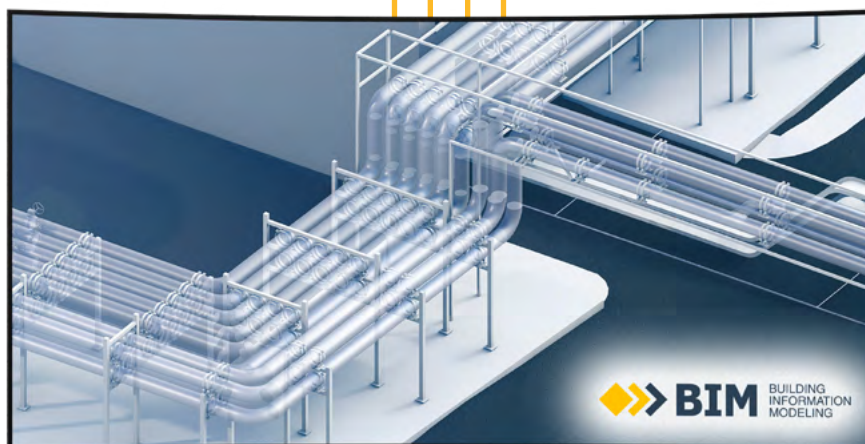

Compatible with:

SiCAD 4 E3D

SiCAD 4 Plant3D

SiCAD 4 S3D

SiCAD 4 REVIT



COUNTLESS APPLICATIONS

It doesn't get more modular than this!

siMetrix is suitable for a wide range of applications thanks to its modularity, innovative One-Screw Technology and identical geometry on all faces. **An innovative concept and easy to use throughout many kinds of projects.**

For example:

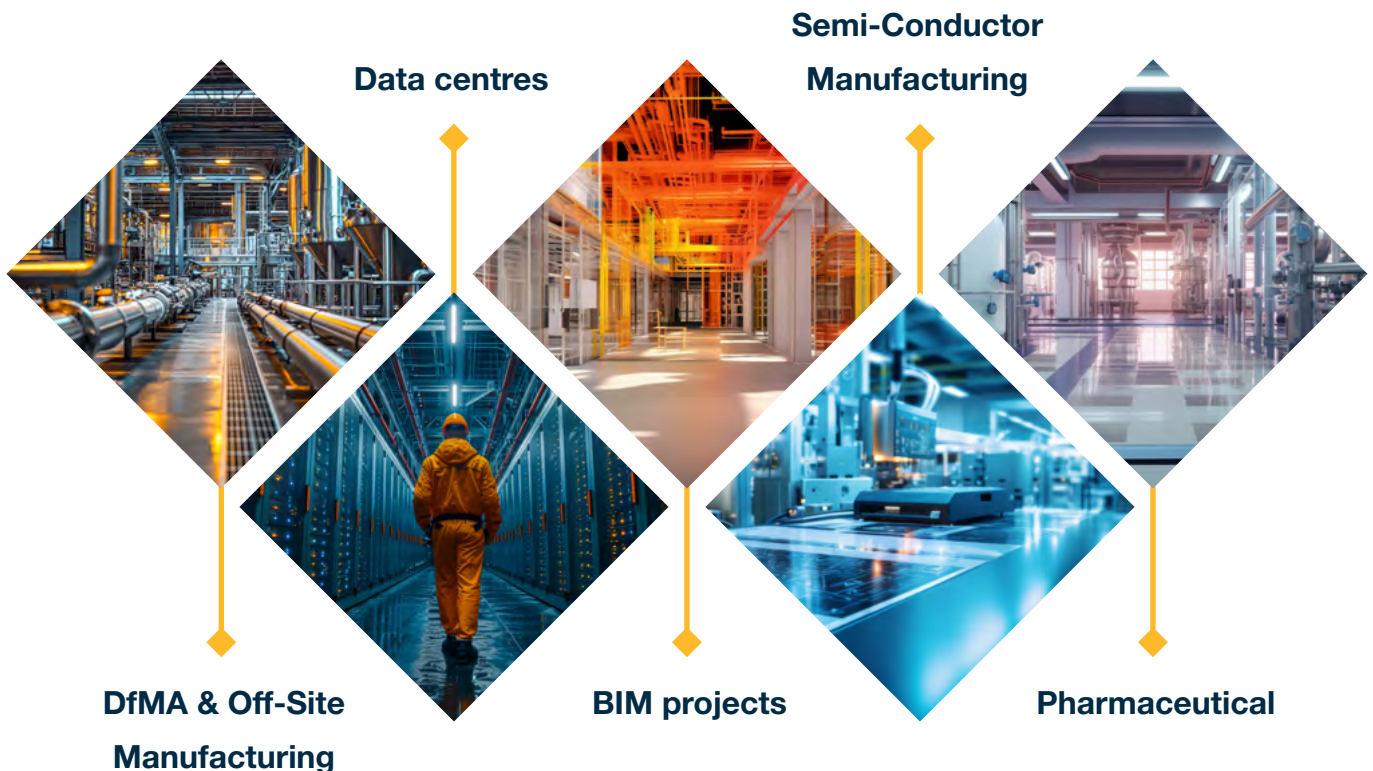

**ARE YOU READY
FOR THE DESIGN
REVOLUTION?**

Get to know the world
of siMetrix!
You can find more information
on our website at
sikla.com/simetrix/en





Ready for **siMetrix?**

THEN CONTACT US!



sikla Together we build.
siklaproof.

Sikla UK Ltd
Unit 3, Newmarket Court
Milton Keynes MK10 0AG
Fon: +44 1908 281 052
miltonkeynes@sikla.co.uk
www.sikla.co.uk